

# 继电器配套底座 Relay Matching Base

CE

CCC

RÖHS

IEC:61984



## 特性 Product features





- 介质耐压可达2000VAC,绝缘电阻1000MΩ  
The dielectric withstand voltage can reach 2000VAC, and the insulation resistance is 1000MΩ
- 带手指保护功能  
With finger protection
- PCB式、螺钉式、导轨式安装形式可供选择  
PCB type, screw type, DIN rail mounting form are available
- 多款插入式模块可供选择,实现通电指示,线路保护功能  
A variety of plug-in modules are available to realize power-on indication and line protection functions
- 可选配件:卡簧、标记牌、插入式模块  
Optional accessories: circlips, marker plates, plug-in modules
- 外壳采用PA66+G20环保阻燃尼龙  
The shell adopts PA66+G20 environmentally friendly flame retardant nylon





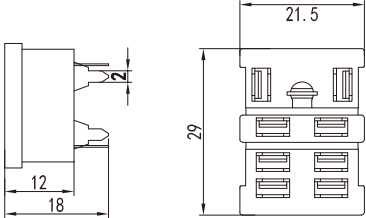
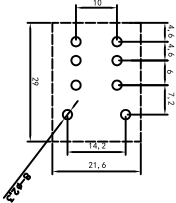

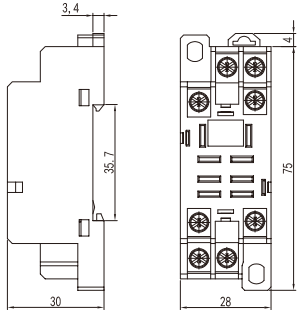
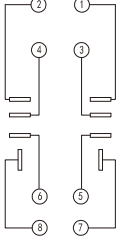
## 性能参数 Performance Parameter

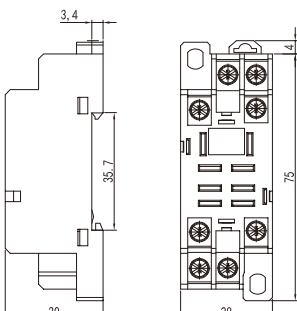
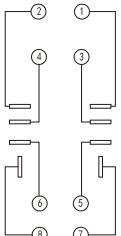
型号 Model	额定电压 Rated Voltage	额定电流 Rated Current	环境温度 Ambient Temperature	介质耐压 Dielectric Strength	插拔寿命 Plug-in life	螺钉扭矩 Screw Torque	外接导线 Size Of Wire	插片材料 Insert material	重量 Weight
RTF08A	250VAC	15A	-35°C~70°C	2000VAC	10000	0.8-1.0N.m	7mm	磷铜	约32g
RTF08A-E	250VAC	15A	-35°C~70°C	2000VAC	10000	0.8-1.0N.m	7mm	磷铜	约33.45g
RTF08A2	250VAC	15A	-35°C~70°C	2000VAC	10000	0.8-1.0N.m	7mm	磷铜	约37.63g
RTF08A-E2	250VAC	15A	-35°C~70°C	2000VAC	10000	0.8-1.0N.m	7mm	磷铜	约39.46g
RT08-C6	250VAC	15A	-35°C~70°C	2000VAC	10000	0.8-1.0N.m	7mm	磷铜	约55.67g
RTF08-PU	250VAC	15A	-35°C~70°C	2000VAC	10000	-	7mm	磷铜	约63.2g
13F-2Z-A1	250VAC	15A	-35°C~70°C	2000VAC	10000	-	-	磷铜	约59.55g

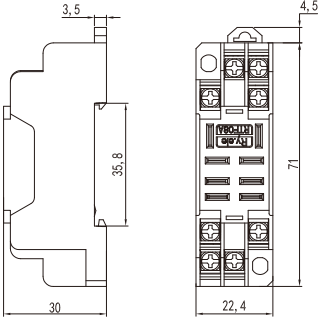
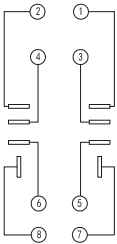
## 外形图、接线图, 安装孔尺寸 Outline drawing, wiring diagram, mounting hole size

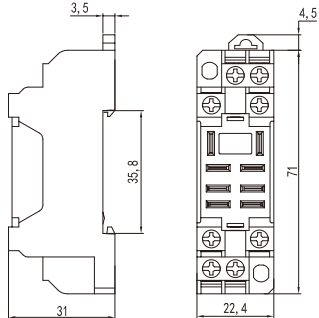
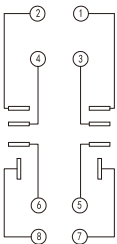
单位: mm

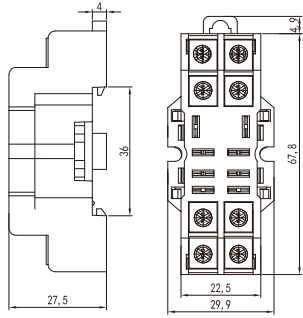
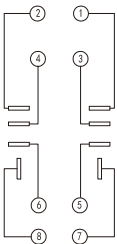
底座 Base	外形尺寸 Form Factor	接线图 Wiring Diagram	可选配件 Optional Accessories
13F-2Z-A1 			挂钩 RY-MG RY-G7
PTF08A 			挂钩 RY-G RY-G1 RY-G2 RYER-G5  连接条 LB-10-29H(蓝blue) LB-10-29HR(红Red) LB-10-29HB(黑black)
PTF08A-E 			挂钩 RY-G RY-G1 RY-G2 RYER-G5  连接条 LB-10-29H(蓝blue) LB-10-29HR(红Red) LB-10-29HB(黑black)

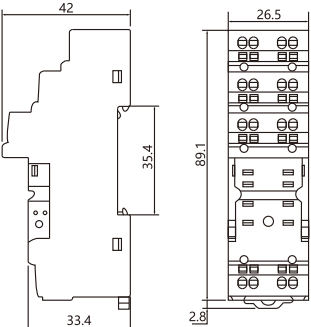
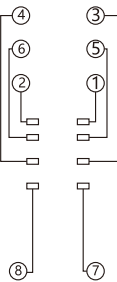
底座 Base	外形尺寸 Form Factor	接线图 Wiring Diagram	可选配件 Optional Accessories
<p>RTF08A2</p> 			<p>挂钩 RY-G RY-G1 RY-G2 RYER-G5</p> <p>连接条 LB-10-22H(蓝blue) LB-10-22HR(红Red) LB-10-22HB(黑black)</p>
<p>RTF08A-E2</p> 			<p>挂钩 RY-G RY-G1 RY-G2 RYER-G5</p> <p>连接条 LB-10-22H(蓝blue) LB-10-22HR(红Red) LB-10-22HB(黑black)</p>
<p>RT08-C6</p> 			<p>挂钩 RY-G3 RY-G4</p>
<p>RTF08A-PU</p> 			

卡簧 Circlips

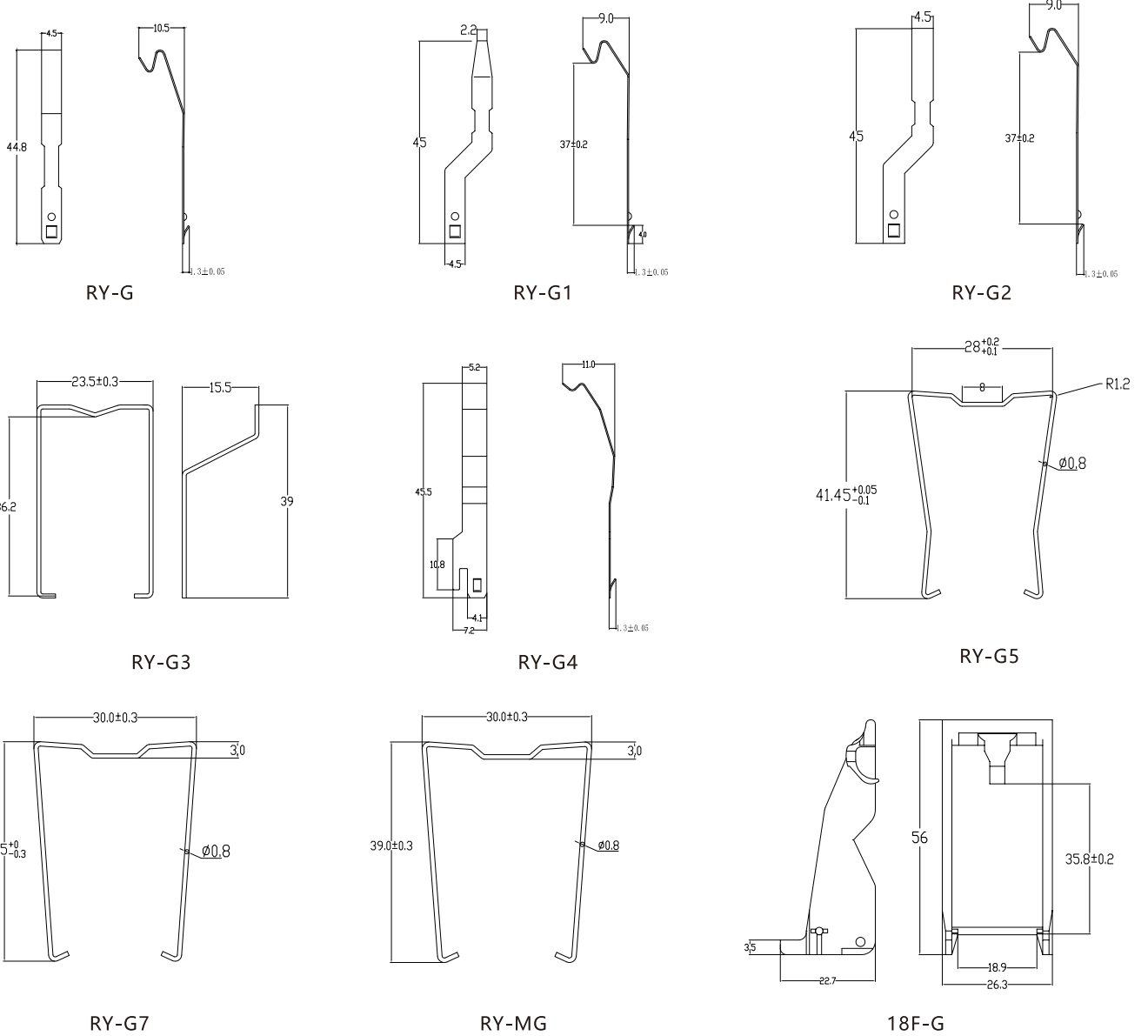

连接条 Connection Strips

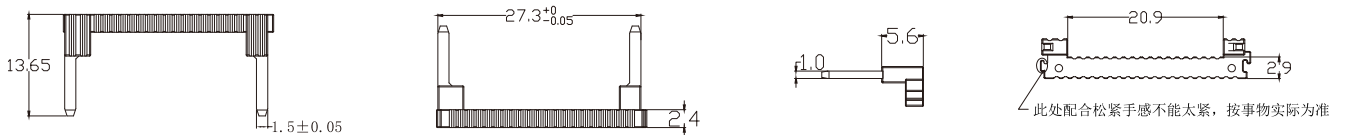

18F-27H(蓝blue) 18F-27HR(红Red) 18F-27HB(黑black)

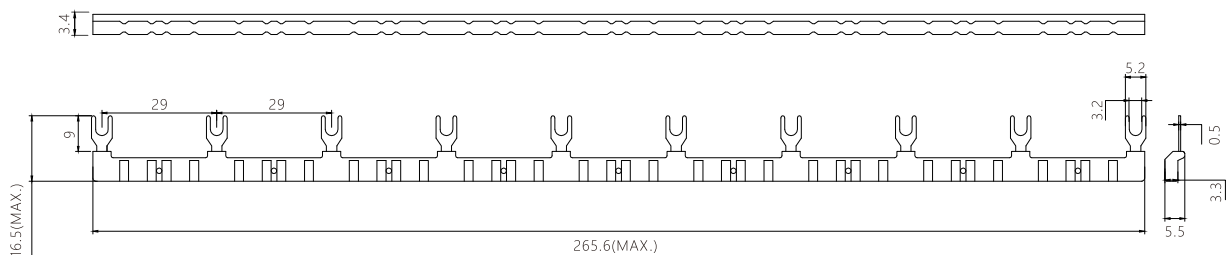

LB-10-29H(蓝blue) LB-10-29HR(红Red) LB-10-29HB(黑black)